

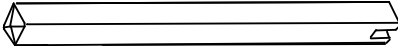

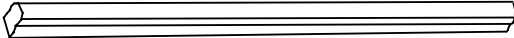





<b>1</b>	20280		1050x70x70 mm	<b>x1</b>
<b>2</b>	20284		3323x55x45 mm	<b>x1</b>
<b>3</b>	20282		812x45x28 mm	<b>x12</b>
<b>4</b>	20281		945x70x70 mm	<b>x1</b>
<b>5</b>	20285		3297x55x25 mm	<b>x1</b>
<b>A</b>	70801		10 gr	<b>x1</b>
<b>B</b>	72895		Ø1.8x35 mm	<b>x12</b>
<b>C</b>	72021		Ø4.5x45 mm	<b>x12</b>
<b>D</b>	72065		Ø5x60 mm	<b>x9</b>
<b>E</b>	72066		Ø6x100 mm	<b>x2</b>
<b>F</b>	72628		Ø15 mm	<b>x11</b>

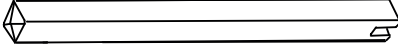
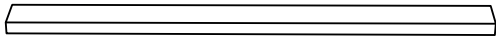

$$B = A - 2C$$

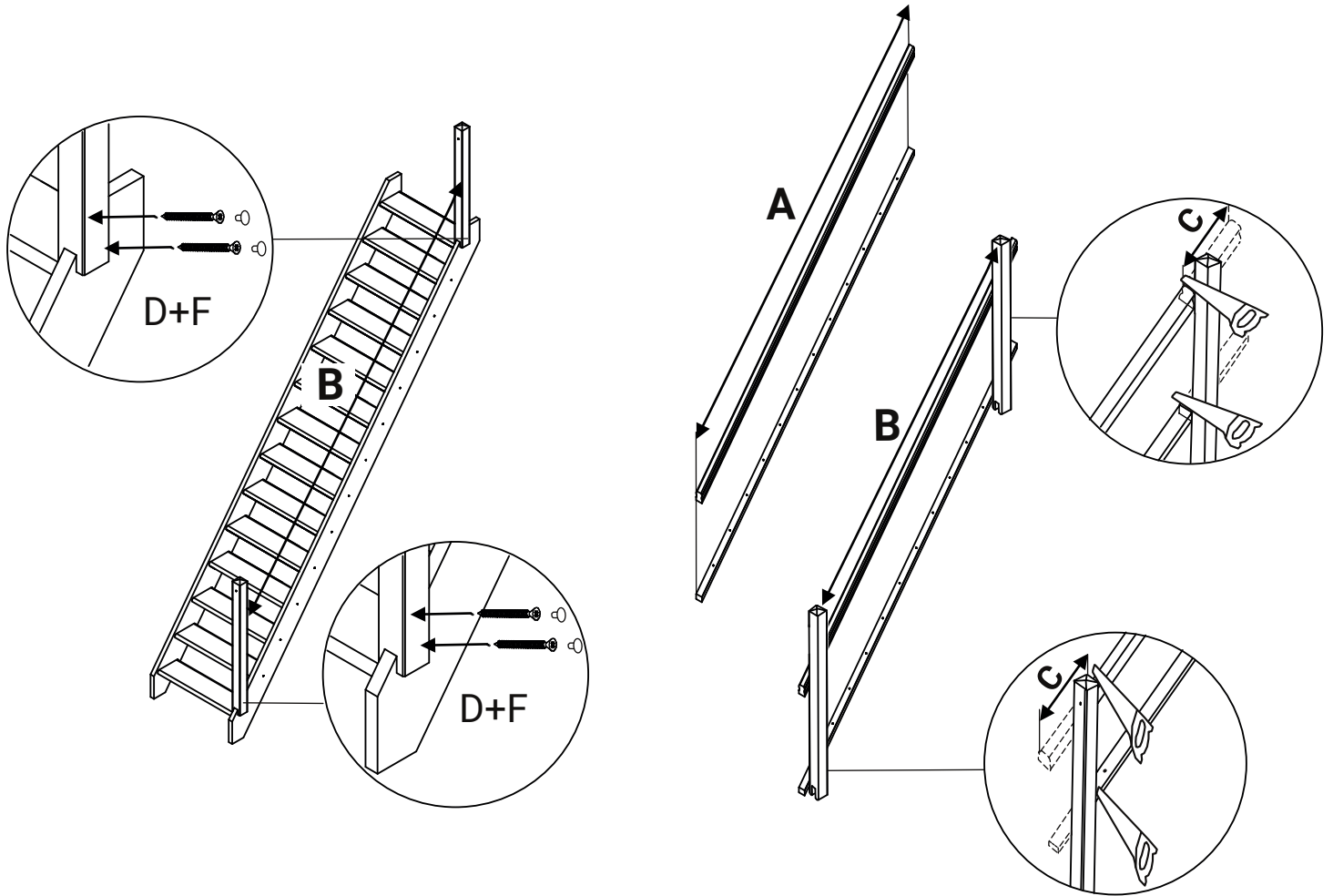