













1	Poteau	■ Pfosten	30046		1077x55x30mm	1
2	Finition poteau	■ Pfosten Endfertigung	70470		55x30x9mm	1
3	Support de tube	■ Stabstütze	70472		25x22x15mm	5
4	Rondelle caoutchouc	■ Gummischeibe	72775		18x11x1.5mm	5
5	Platine pied	■ Fußplatte	70477		100x120mm	1
6	Tige main-courante	■ Handlaufstange	70469		93.3x15.2x13.6mm	1
7	Support Main-courante	■ Handlauf Stütze	70471		70x15.2x11mm	1
8	Ame	■ Befestigungstange	70475		Ø14x118mm	1
9	Finition poteau basse	■ Pfosten Endfertigung Unterteil	70474		55x30x9mm	1
A	Vis A	■ Schraube A	72776		M8x40	2
B	Vis B	■ Schraube B	72548		M5X14	1
C	Vis C	■ Schraube C	72067		M5x6	7
D	Vis D	■ Schraube D	72675		M5x12	2

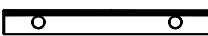

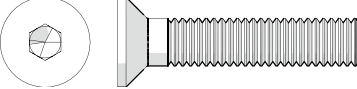
# 1 | MONTAGE DU POTEAU

DE PFOSTEN MONTAGE

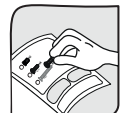
2374\_MAJ\_06/02/2023

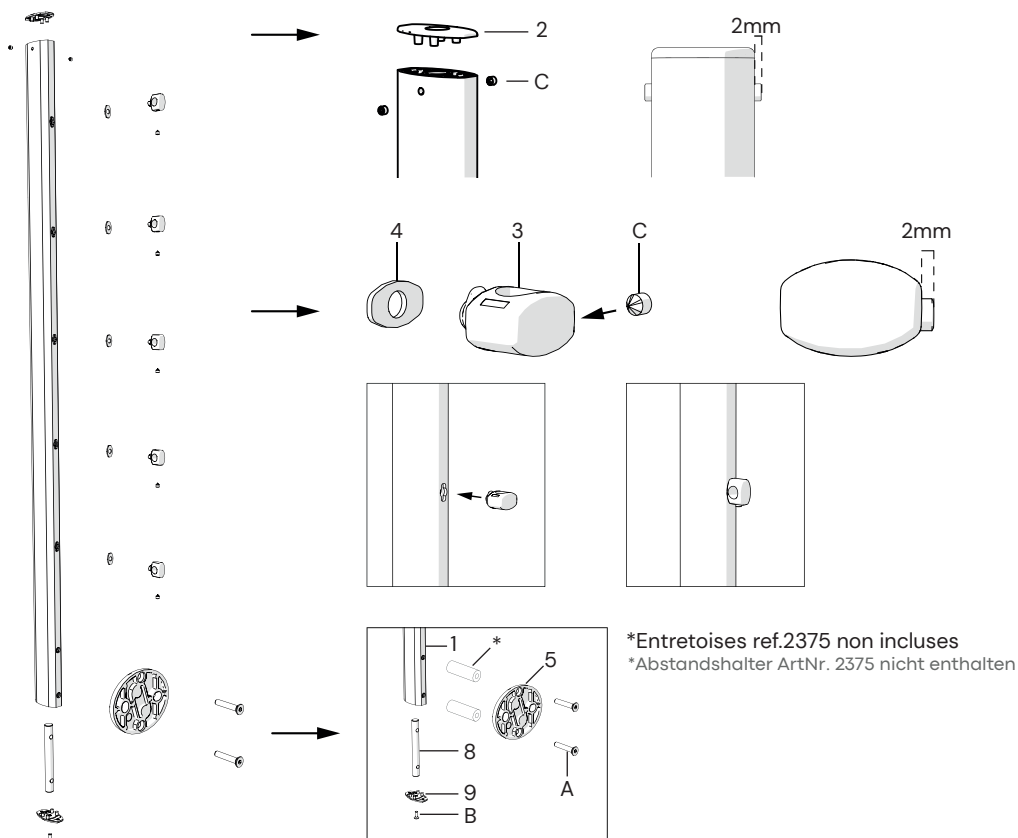

# 2 | FIXATION MAIN-COURANTE

DE BEFESTIGUNG DES HANDLAUFS

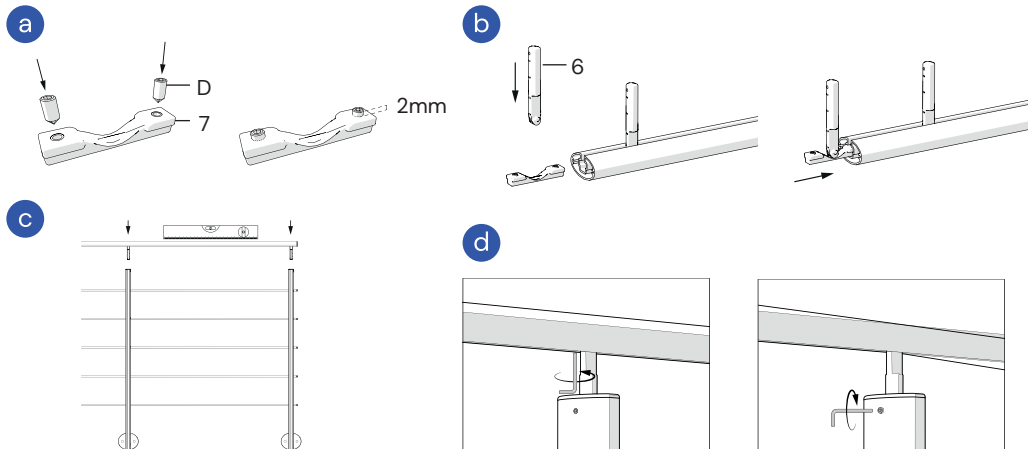

La durée et les conditions de garanties peuvent être consultées sur : <https://b2b.kordodesign.com/garanties>.  
Die Dauer- und die Garantiebedingungen können unter : <https://b2b.kordodesign.com/garantien> eingesehen werden.