











1	Poteau	■ Pfosten	30047		926x55x30mm	1
2	Finition poteau	■ Pfosten Endfertigung	70479		55x30x9mm	1
3	Support de tube	■ Stabstütze	70481		25x22x15mm	5
4	Rondelle caoutchouc	■ Gummischeibe	72775		18x11x1.5mm	5
5	Platine pied	■ Fußplatte	70486		100x120mm	1
6	Tige main-courante	■ Handlaufstange	70478		93.3x15.2x13.6mm	1
7	Support Main-courante	■ Handlauf Stütze	70480		70x15.2x11mm	1
A	Vis A	■ Schraube A	72557		M6x60	2
B	Vis B	■ Schraube B	72067		M5x6	7
C	Vis C	■ Schraube C	72675		M5x12	2
D	Vis D	■ Schraube D	72338		M10x16	2



# 1 | MONTAGE DU POTEAU

DE PFOSTEN MONTAGE

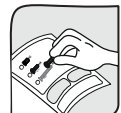
2382\_MAJ\_06/02/2023

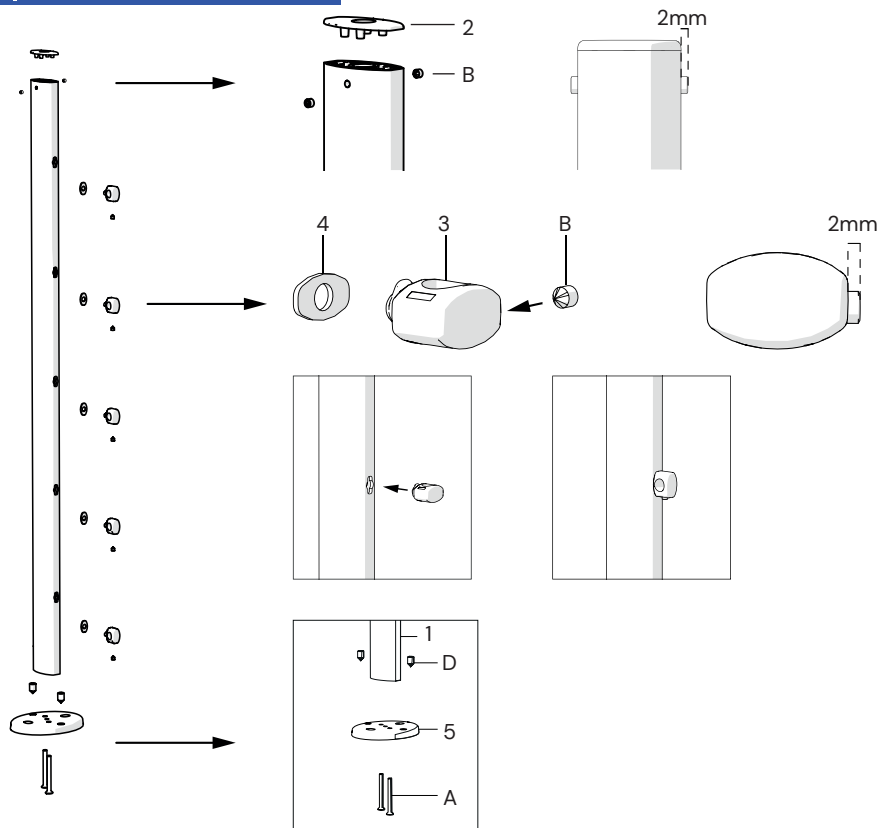

# 2 | FIXATION MAIN-COURANTE

DE BEFESTIGUNG DES HANDLAUFS

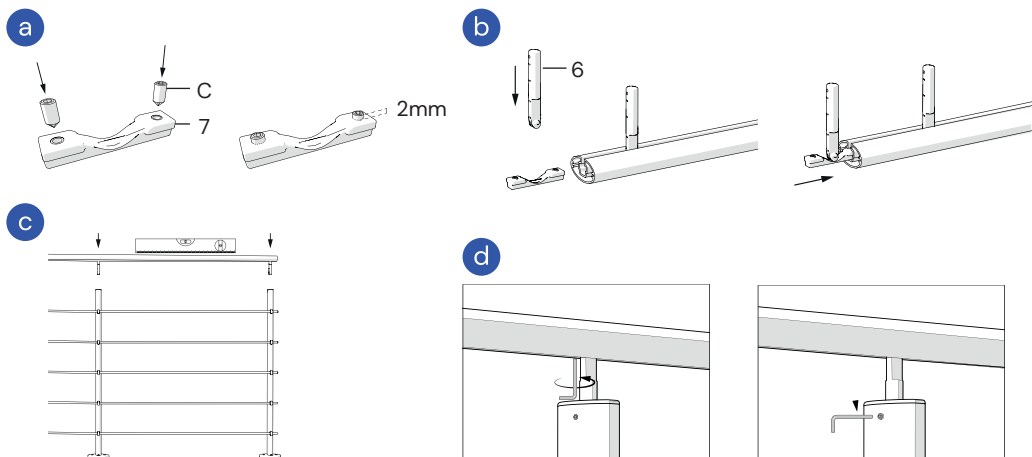

La durée et les conditions de garanties peuvent être consultées sur : <https://b2b.kordodesign.com/garanties>.  
Die Dauer- und die Garantiebedingungen können unter : <https://b2b.kordodesign.com/garantien> eingesehen werden.