

kordo.

une marque du groupe
BURGER

A

PANNEAU ANTICHUTE

protection panel

REF. 2380

RAL9005

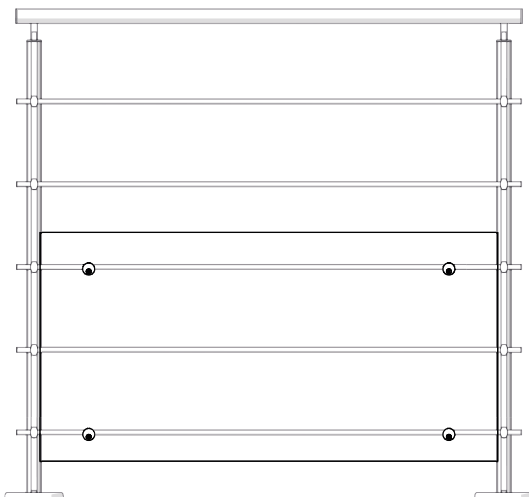

- **1 panneau synthétique**
transparent traité UV dimensions
4x470x940mm
*1 UV treated transparent synthetic
glass panel size 4x470x940mm*

- **4 supports de vitre et vis Inox A2**
*4 glass holders and A2 stainless
steel screws*

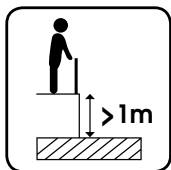
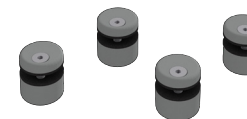
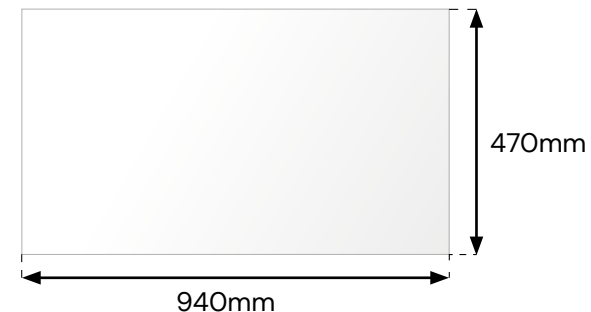

Conforme aux normes NF P01-012 et NF P01-013 s'appliquant pour une hauteur de chute supérieure à 1 mètre.
Conform to NF P01-012 and NF P01-013 standards for installation height over 1 meter.

www.kordodesign.com

La durée et les conditions de garanties peuvent être consultées sur : <https://b2b.kordodesign.com/garanties>.

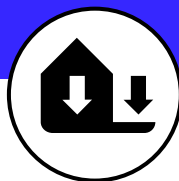

3443440023807

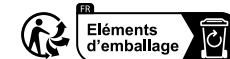

GUIDE DE MONTAGE

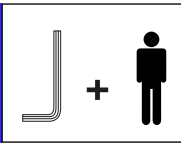

Support verre A	70511		Ø25,3x13mm	x4
Caoutchouc	72780		Ø25x1,5mm	x8
Support verre B	70512		Ø25,1x5mm	x4
Vis	72888		M5x20	x4
Verre synthétique	70812		940x470	x1

